

HD208

▶ [GB] Minidatalogger

 Temperature

 Humidity



Minidatalogger

Temperature – Temperature/Relative humidity



- Temperature or temperature / relative humidity and dew point data logger
- Available models with fixed probe or probe with cable
- Manual, also with configurable delay time, or programmed (date and time) logging start
- Measurement alarms with configurable thresholds
- USB output
- Automatically generates **PDF** reports and **CSV** files
- Software for configuration, monitor and data download supplied
- Software option available for compliance with **FDA 21 CFR part 11** recommendations
- LCD display and LED indicators for power, logging and alarms.
- Long life lithium battery
- Excellent weather protection



APPLICATIONS

- Monitoring of goods (food, drugs, plants, perishable products in general) during transport and storage
- Laboratories
- Museums and document archives

DESCRIPTION

The data loggers of the series **HD208** are compact instruments for monitoring temperature, relative humidity (RH) and dew point temperature. Usable in a wide spectrum of applications, are available in various models:

- With 1 channel for temperature only (depending on the model, the sensor can be internal, external fixed or external with cable).
- With 1 channel for temperature and relative humidity (combined probe fixed or with cable).
- With 2 channels for temperature only (one external sensor with cable and one internal sensor).
- With 2 channels: one for temperature and relative humidity (combined probe with cable) and one for temperature only (internal sensor).

All models can be supplied with or without LCD display.

The logging function is extremely versatile; logging can be started and stopped manually, by means of the front buttons, or the start and stop date and time of acquisition can be programmed. The delayed start capability allows starting the logging with a configurable delay time after pressing the button for the manual start.

For each quantity detected, two configurable alarm thresholds can alert the user if the measure exceeds the configured parameters.

The instrument automatically generates, after logging, a **PDF report** with charts of the variables collected and a **CSV file** with all measurements logged. The PDF and CSV files can then be copied to the PC via the USB port, without any dedicated software: the instrument is recognized as a USB flash drive.

The basic application software **HD35AP-S** supplied with the instrument allows the configuration of the instrument, the real-time monitor of the measurements and the transfer of the acquired data into a database. The connection to the PC does not require any installation of USB drivers, thereby ensuring compatibility with all versions of the Windows® operating system.

The **HD35AP-CFR21** application software option allows the use of security features of the recorded data and configuration of the instrument in response to **FDA 21 CFR part 11** recommendations.

Powered by a 3.6 V **non rechargeable** lithium-thionyl chloride battery (Li-SOCl₂).

The sensors are pre-calibrated and require no further calibration by the user. If necessary, the user can perform a new calibration using the HD35AP-S application software.

All versions can be ACCREDIA certified, upon quote.



Power supply LED (POWER): briefly flashes every 10 seconds to indicate that the instrument is powered. It is steady on if the instrument is connected to the PC.

Logging LED (LOG): briefly flashes three times when logging starts and stops, and every 10 seconds during logging.

Alarm LED (ALARM): briefly flashes every 10 seconds if any of the measured quantities is in alarm.

START/MODE button: by pressing it briefly, you change the type of information displayed (measures, date/time, alarm thresholds, logging settings); if pressed for more than 2 seconds, manually starts logging. In models without LCD, the button performs only the START function.

STOP/Scroll button: by pressing it briefly, you change the parameter displayed (the parameter depends on the type of information selected with the START/MODE button); if pressed for more than 2 seconds, manually stops logging. In models without LCD, the button performs only the STOP function.

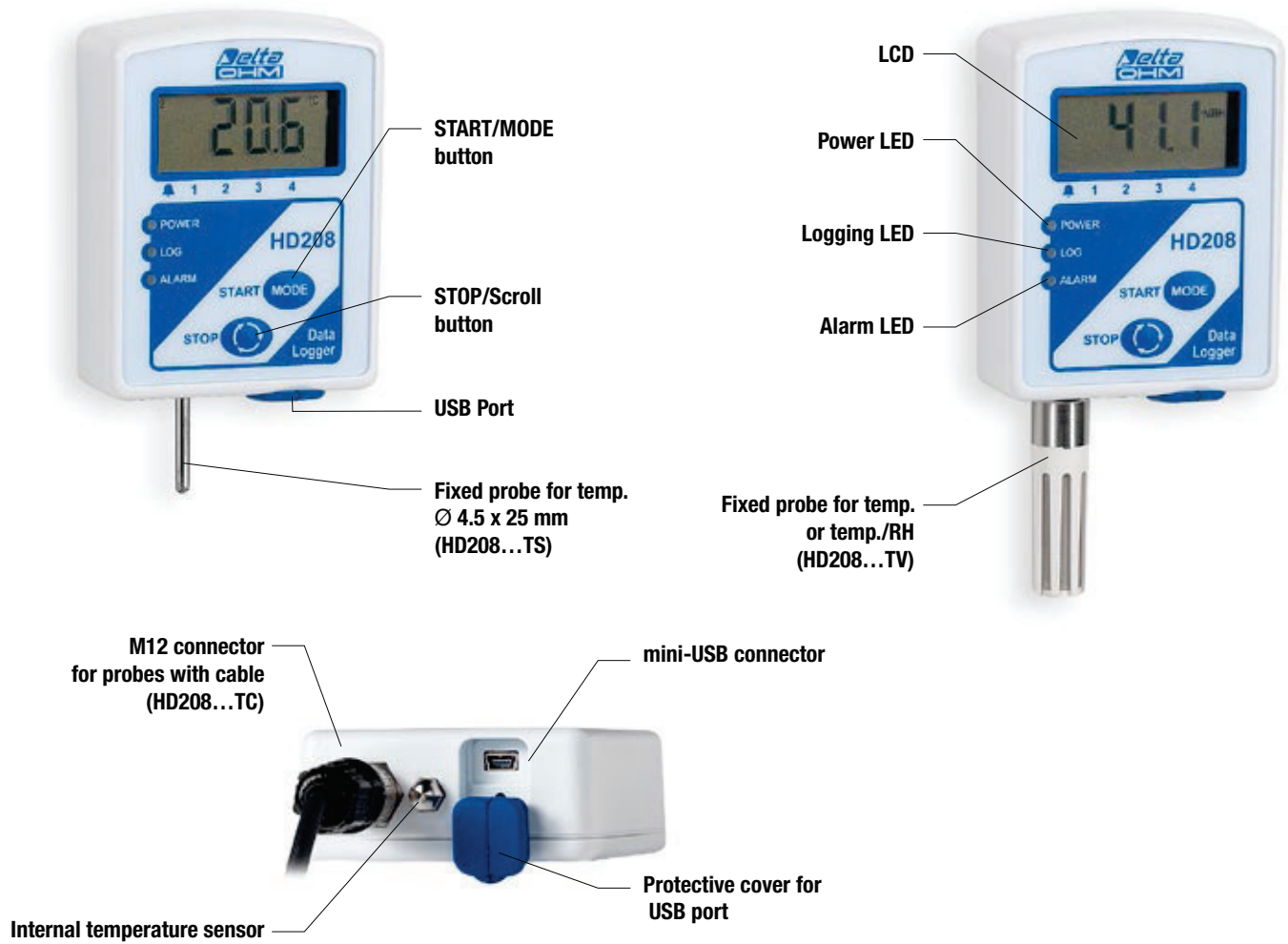

SPECIFICATIONS

Relative Humidity	
Sensor	Capacitive
Measuring range	0...100 %RH
Resolution	0.1%RH
Accuracy	± 1.5 %RH (0...85 %RH) / ± 2.5 %RH (85...100 %RH) @ T=15...35 °C $\pm (2 + 1.5\% \text{ measure})\%$ @ T=remaining range
Sensor operating temperature	-40...+80 °C standard / -40...+150 °C with the probe HP3517E2... for high temperature
Response time	$T_{90} < 20$ s (air speed 2 m/s, without filter)
Temperature drift	$\pm 2\%$ over the whole operating temperature range
Stability	1% / year
Temperature	
Sensor	Pt1000 or NTC10k Ω @ 25 °C depending on the model
Measuring range	NTC10kΩ : -40...+105 °C Pt1000 : -50...+300 °C The measuring range can be limited by the operating temperature of the probe used and, in the case of internal sensor or external fixed probe, by the maximum operating temperature of the instrument (+75 °C).
Resolution	0.1 °C
Accuracy	NTC10kΩ : ± 0.3 °C in the range 0...+70 °C / ± 0.4 °C outside Pt1000 : class A, $\pm (0,15 + 0,002 t)$ °C
Long term stability	0.1 °C / year
Unit of measurement	°C or °F
Logging interval	1, 2, 5, 10, 15, 30 s / 1, 2, 5, 10, 15, 30, 60 min
Storable quantities	According to the model: <ul style="list-style-type: none"> Temperature: internal sensor, fixed external probe or external sensor with cable; Mean Kinetic Temperature (MKT) calculated; the models with two temperature channels (internal sensor and external probe with cable) store both temperatures. Relative Humidity. Dew Point. Battery Voltage.
Memory	Flash memory with circular management or stop logging when full. The PDF report is generated with the data stored in the Flash memory and the maximum number of samples (Ns) is: $N_s = \frac{921,600}{(1+0.75 \times N_g)}$ <p>Example:</p> <ul style="list-style-type: none"> > 526,000 with one quantity stored ($N_g=1$) > 147,000 with seven quantities stored ($N_g=7$) <p>The maximum number of samples in the CSV files is instead limited only by the capacity of the 4 GB SD memory.</p>
Alarms	Two alarm thresholds (configurable) for each measured quantity
Power supply	3.6 V not rechargeable lithium-thionyl chloride internal battery (Li-SOCl ₂), size AA, 2-pole Molex 5264 connector.
Battery life	2 years typical, with logging interval 30 s
PC connection	USB port with mini-USB connector
Temperature/humidity of the instrument	-40...+75 °C / 0...100 %RH non condensing
Material	LURAN® S 777K
Dimensions	Case: 70 x 90 x 30 mm Size of the TV model with fixed probe: 70 x 138 x 30 mm
Prection degree	IP 64
Weight	150 g approx.
Installation	Wall mount



HD208 fixed probe \varnothing 4.5x25mm



HD208 with internal NTC sensor

MODELS WITH LCD

In models with LCD, **MODE** and **SCROLL** buttons allow viewing a variety of information. With the **MODE** button (short press) you choose the type of information: measurements, date and time of the instrument, alarm thresholds, start and stop instants of programmed logging, delay time for the manual start of logging. With the **SCROLL** button (short press) you navigate through the various fields of the type of information selected (see function diagram shown below). The buttons operation is cyclical.

If you press the **SCROLL** button when the display shows the last of the quantities available on the display, the instrument does not return immediately to the first quantity, but starts to automatically cycle through all the available quantities. Press **SCROLL** again to return to the permanent display of the first quantity.

If a parameter is not set, the instrument will display dashes.

Alarm symbols on display

In addition to the alarm LEDs, there are four alarm indications on the display; an arrow lights up in correspondence of the alarms 1, 2, 3 and 4 if:

- Alarm 1: the temperature is below the lower threshold configured.
- Alarm 2: the temperature is above the upper threshold configured.
- Alarm 3: the relative humidity is below the lower threshold configured.
- Alarm 4: the relative humidity is above the upper threshold configured.

If the model measures two temperatures: external sensor (channel 1) and internal sensor (channel 2), alarms 1 and 2 refer to the temperature measured by the external sensor (channel 1).

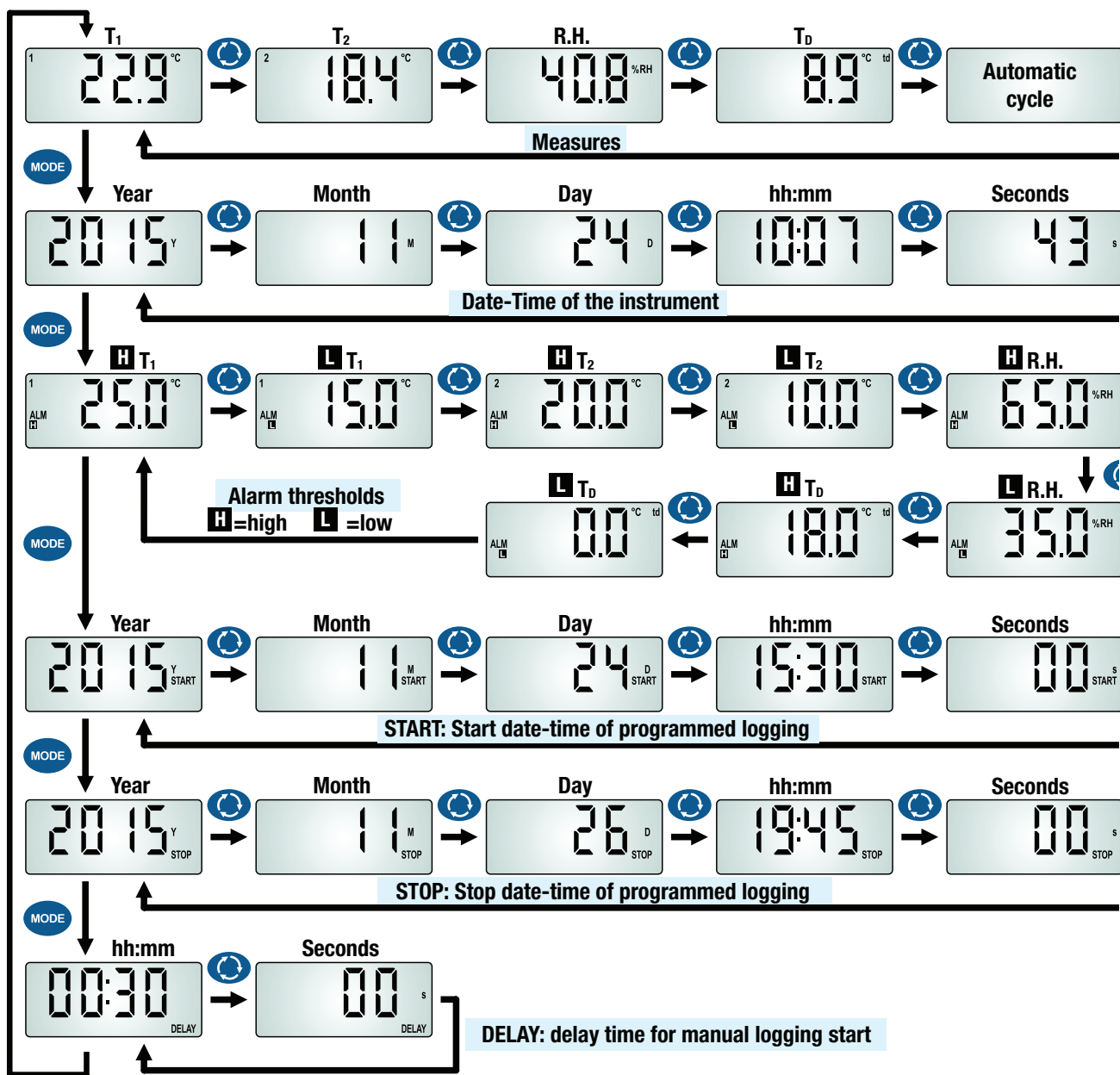

Error messages on display

If a detected quantity is in error, the following indications appear on display:

- UFL:** the measured value is less than the minimum measurable (Underflow).
- OFL:** the measured value is greater than the maximum measurable (Overflow).

LOGGING

The start of logging can be:

- Automatic,** by programming the start date and time.
- Manual,** by pressing for more than 2 seconds the button START/MODE.
- Delayed:** logging does not start immediately when you press the START/MODE button, but after the delay time set.

Logging stop can be automatic, by programming the stop date and time or the number of samples to acquire, or manually, by pressing for more than 2 seconds the STOP/ Scroll button.

The programmed time and the delay time are set using the software HD35AP-S.

During logging, the LOG symbol on the display and the LOG LED flash. In case of delayed start, during the delay time the DELAY symbol appears on the display, indicating that the instrument is waiting to start logging.

Alarm 2: temperature > upper threshold

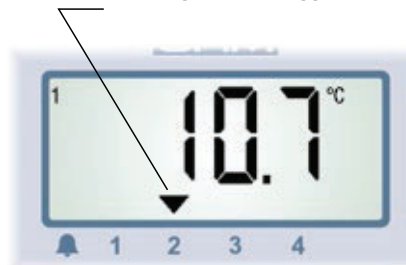

PDF REPORT

At the end of each logging session, the data logger automatically generates a PDF report, which can then be copied to the PC via the USB port of the instrument. When generating the report, the display of the instrument shows **PDF**.

The report includes the graphs of the detected quantities and information about the logging session: logging start and stop time, logging interval, number of samples acquired, alarm thresholds, minimum, average and maximum of each detected quantity.

The report includes the calculation of the **Mean Kinetic Temperature (MKT)**. The Mean Kinetic Temperature is an evaluation index of the cold chain used in the pharmaceutical field, and is calculated according to the Haynes equation as a function of all the temperature measurements acquired during the logging session. The Mean Kinetic Temperature is used to evaluate temperature fluctuations experienced by a biological substance during storage or transport, and corresponds to the storage temperature that, if maintained constant, produces on the biological substance the same effects of the actual temperature changes recorded in the time period considered (i.e. the duration of the logging). You can set the value of the activation energy, parameter necessary for the calculation of MKT.

DATA REPORT

Delta Ohm s.r.l.

TempLogger Temperature/RH Logger

DATA SUMMARY

S.N.:	15037735	Session Number:	1
Recording Start:	2015-11-25 10:49:24	Recording Stop:	2015-11-25 11:40:20
Number of Samples:	3056	Sampling Interval:	1 s
Start reason:	BUTTON PRESS	Stop Reason:	BUTTON PRESS
Calibration date:	2015-11-20	Calibration used:	Factory
CFR Enabled:	NO	CFR User:	N/A
Measure:	TMP1	MKT:	MKT1
Type:	TEMPERATURE	Value:	23.5 °C
Max:	25.2 °C	High Alarm Level:	27.0 °C
Min:	23.2 °C	Low Alarm Level:	5.0 °C
Avg:	23.6 °C	High Alarm time:	0 s
High Alarm Level:	30.0 °C	Low Alarm time:	0 s
Low Alarm Level:	-10.0 °C		
High Alarm time:	0 s		
Low Alarm time:	0 s		
Measure:	TMP2	MKT:	MKT2
Type:	TEMPERATURE	Value:	23.7 °C
Max:	25.4 °C	High Alarm Level:	27.0 °C
Min:	23.1 °C	Low Alarm Level:	5.0 °C
Avg:	23.5 °C	High Alarm time:	0 s
High Alarm Level:	30.0 °C	Low Alarm time:	0 s
Low Alarm Level:	-10.0 °C		
High Alarm time:	0 s		
Low Alarm time:	0 s		
Measure:	RH	Measure:	DP
Type:	RH%	Type:	DEW POINT
Max:	74.6 %	Max:	19.9 °C
Min:	26.5 %	Min:	4.8 °C
Avg:	31.6 %	Avg:	6.2 °C
High Alarm Level:	80.0 %	High Alarm Level:	80.0 °C
Low Alarm Level:	5.0 %	Low Alarm Level:	-10.0 °C
High Alarm time:	0 s	High Alarm time:	0 s
Low Alarm time:	0 s	Low Alarm time:	0 s

Delta Ohm srl - Via G. Marconi, 5 - 35030 Caselle di Selvazzano (PD) - ITALY
Tel. 0039 0498977150 Fax 0039 049635596 - email: info@deltaohm.com - web: www.deltaohm.com

In the graphs are shown in gray the areas of alarm (values that exceed the thresholds set).

The time required to generate the PDF file depends on the amount of data acquired, and can go from a few seconds (if the amount of data acquired is limited) up to about a minute.

Note: the PDF report is generated with the data stored in the Flash memory; the number of samples in the Flash memory may be less than the number of samples stored in the CSV file (please see the memory capacity in the specifications table).

The generation of the PDF report can be enabled/disabled by using the HD35AP-S application software or, alternatively, by holding pressed the STOP button and then pressing the reset button located on the electronic board (above the battery connector).

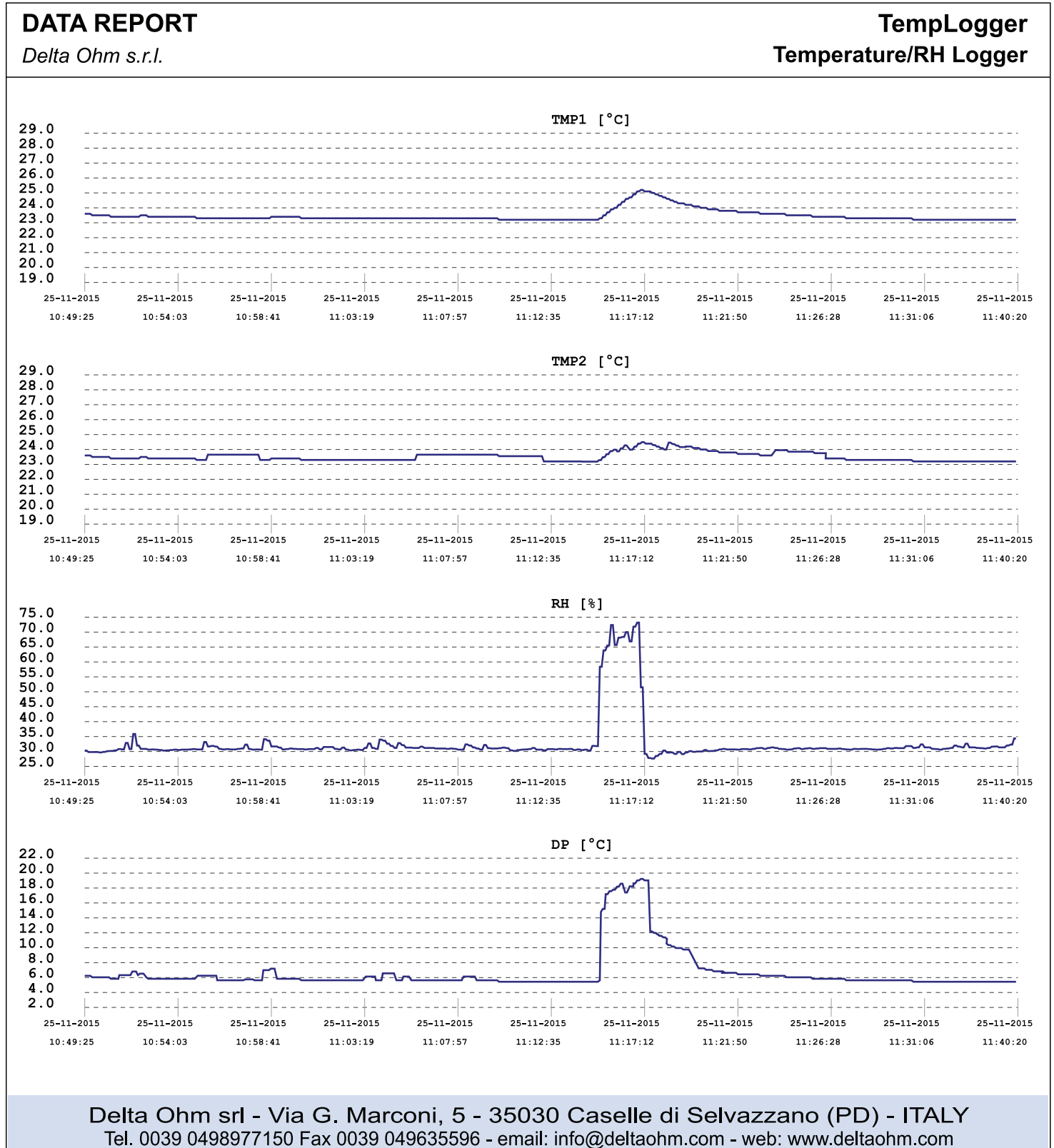

Delta Ohm srl - Via G. Marconi, 5 - 35030 Caselle di Selvazzano (PD) - ITALY
Tel. 0039 0498977150 Fax 0039 049635596 - email: info@deltaohm.com - web: www.deltaohm.com

CONNECTION TO THE PC

Pull out the protection of the USB output and connect the instrument to the PC by using the cable **CP23**. If the instrument is **not** logging, the PC detects it as a simple USB flash drive and appears the list of PDF and CSV files with the reports and the data of the logging sessions.

In order to transfer data from the internal memory of the instrument in a database in the PC, use the HD35AP-S application software following the on-line instructions of the software.

During logging it is possible to connect through the HD35AP-S software and display the measurements in real time (Monitor), but you cannot copy the PDF and CSV files in the instrument.

The connection to the PC does not require any USB driver installation.

In order to disconnect the instrument from the PC, use the "Safely Remove Hardware" function provided by the operating system. When the instrument is not connected to the PC, reposition into place the protective cap of the USB output.

Note: during PDF report generation at the end of a logging session, the instrument does not respond to the PC; wait for the instrument to finish saving the PDF file.

CONFIGURATION

The instrument parameters (date/time, logging parameters, alarm thresholds, quantities to be acquired) are configurable by connecting the instrument to a PC and using the HD35AP-S application software or, alternatively, a specially designed **PDF form** (the use of the PDF form must be enabled with HD35AP-S software).

ADVANCED SOFTWARE OPTIONS

The **HD35AP-PLUS** and **HD35AP-CFR21** software options allow you to activate additional features of the HD35AP-S software.

The **HD35AP-PLUS** option allows the **multi-client** connection to the database: it is possible to store the data in a remote database on the local network to which the PC is connected, and the data can be viewed from any PC on the network via the HD35AP S software (with the basic version, only the local database of the PC where the software is installed is usable).

The **HD35AP-CFR21** option allows, in addition to the features of the PLUS option, the protection of recorded data and configuration of the instrument in response to **FDA 21 CFR part 11** recommendations. In particular become available:

- The traceability of activities (audit trail) performed with the software; for example, which users connected and what changes were possibly made to the configuration of the instrument.
- The management of users access for the instrument configuration and viewing of data in the database. Each user can be assigned a different password for using the software. There are also three levels of access (Administrator, Super-user and standard User); for each level, the allowed operations can be defined.
- The protection of the database in which you download the data: you can make sure that data can be downloaded only in a particular database, preventing the downloading of data in different databases.

The software options are enabled by a HD208 data logger operating as hardware key when connected to the software. If more than a data logger of the series HD208 is available, it is sufficient that only one of them operates as hardware key to enable the additional features and use them with the remaining data loggers.

Monitor of the measures

Device information

Data base time interval selection

Selection of devices and quantities

Users permissions (only with HD35AP-CFR21 option)

Graph of measures

Measures

DATABASE

Setup	SN	Firmware version	User code	Measuring interval	Ch 01 lower threshold	Ch 01 upper threshold	Battery level
HD208	15023723	0.197	greenhouse 3	15 (sec)	0,0 (°C)	100,0 (°C)	

Date Time	Code	SN	User code	Group
2015/12/11 11:42:30	hd208	15023723	greenhouse 3	GRP NAME

ID	Registration Date	Role	Description	Status	Name	Last Name	Address	Position
01	11/11/2015 15:55:00	Supervisor A	Supervisor A	Active	Name 1	Surname 1	Address 1	Supervisor
02	11/11/2015 15:54:37	Supervisor B	Supervisor B	Active	Name 2	Surname 2	Address 2	Supervisor
03	11/11/2015 15:26:19	User A	User A	Active	Name 3	Surname 3	Address 3	User
04	11/11/2015 15:26:59	User B	User B	Active	Name 4	Surname 4	Address 4	User
05	11/11/2015 15:27:47	User C	User C	Active	Name 5	Surname 5	Address 5	User
06	11/11/2015 15:27:47	User D	User D	Active	Name 6	Surname 6	Address 6	User



INSTALLATION OF THE INSTRUMENT

The case of the instrument is provided with a hole on the back to fix it to a support (screw or hook) on the wall. Insert the head of the support in the lower part of the hole (width 10 mm) and lower the instrument so that the head of the support remains wedged in the upper part of the hole (width 6 mm). Make sure that the instrument cannot accidentally come out from the support.



BATTERY

The instrument uses a 3.6 V **non-rechargeable** lithium-thionyl chloride (Li-SOCl₂) battery AA size. To connect the battery, or to replace a dead battery with a new one, proceed as follows:

1. Unscrew the 4 screws on the back of the case and remove the back cover.
2. In case of replacement, disconnect the battery connector from the circuit board and replace the battery with a new one of the same type.
3. Connect the battery connector to the circuit board, observing the correct polarity. The connector is equipped with a polarization key that prevents the possibility of a wrong insertion of the connector.
4. Close the case by fixing the 4 rear screws (pay attention to the correct placement of the battery, not to hinder the closing of the case).

The battery symbol at the bottom left of the display lights up when the battery is low; in this case, replace the battery as soon as possible.



Internal battery



Alternatively, a fixed installation can be realized, using the **optional HD208.13** aluminium flange to be fixed on the back of the instrument case.



ORDERING CODES

HD208... Datalogger for temperature or temperature/relative humidity and dew point. **Optional LCD Display.** Configurable measurement alarms. USB output. Powered by 3.6 V non-rechargeable lithium-thionyl chloride internal battery (Li-SOCl₂). Supplied with: basic software **HD35AP-S**, battery, user manual. **The USB cable CP23 and the external probe with cable must be ordered separately.**

HD208	PROBE TYPE:
	<p>No letters = only internal temperature sensor</p> <p>TC = only external probe with cable</p> <p>TS = only external fixed temperature probe with stainless steel tube</p> <p>TV = only external fixed temperature probe with Pocol protective cap and stainless steel grid</p> <p>TCI = external probe with cable + internal temperature sensor</p>
	<p>QUANTITIES MEASURED:</p> <p>N = temperature with NTC10kΩ sensor</p> <p>7P = temperature with Pt1000 sensor</p> <p>1N = temperature (NTC10kΩ sensor) and relative humidity</p> <p>17P = temperature (Pt1000 sensor) and relative humidity</p> <p>Options 7P and 17P (Pt1000 sensor) are possible only with external probe with cable.</p>
LCD:	<p>No letters = without LCD, L = with LCD</p>

Temperature probes with NTC10kΩ@ 25 °C sensor

TP35N1... Temperature probe with **NTC10KΩ** sensor. Operating temperature: -20...+75 °C. Accuracy: ± 0.3 °C in the range 0...+70 °C / ± 0.4 °C outside. Dimensions: Ø 5 x 40 mm. AISI 316 stainless steel tube. M12 4-pole female connector.

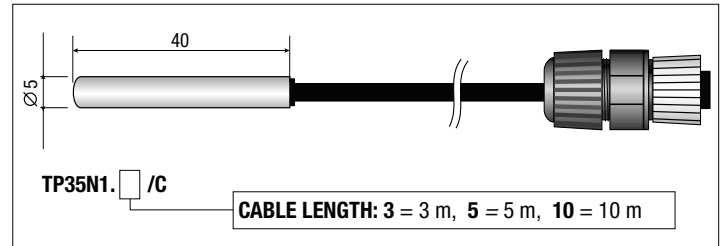

TP35N2... Temperature probe with **NTC10KΩ** sensor. Operating temperature: 0...+75 °C. Accuracy: ± 0.3 °C in the range 0...+70 °C / ± 0.4 °C outside. Dimensions: Ø 6 x 50 mm. AISI 316 stainless steel tube. M12 4-pole female connector.

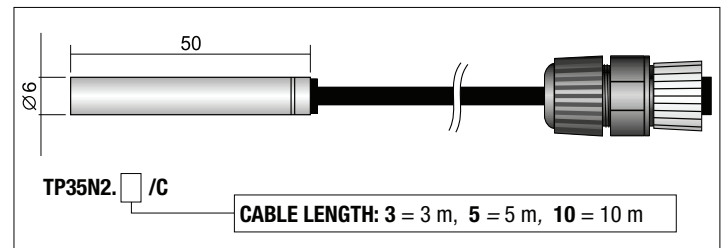

TP35N5... Penetration temperature probe with **NTC10KΩ** sensor. Operating temperature: -20...+105 °C. Accuracy: ± 0.3 °C in the range 0...+70 °C / ± 0.4 °C outside. Dimensions: Ø 4 x 100 mm. AISI 316 stainless steel tube. M12 4-pole female connector.

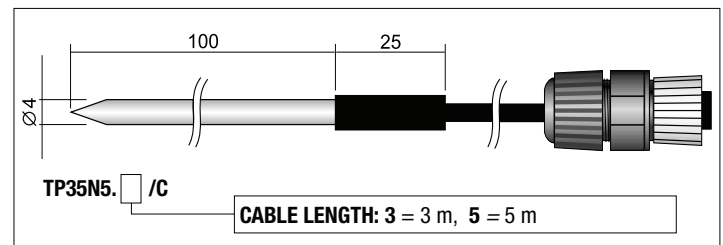

Temperature probes with Pt1000 sensor

TP35.1... Temperature probe with **Pt1000** 1/3 DIN 4-wire sensor. Operating temperature: -50...+105 °C. Dimensions: Ø 5 x 40 mm. AISI 316 stainless steel tube. M12 4-pole female connector.

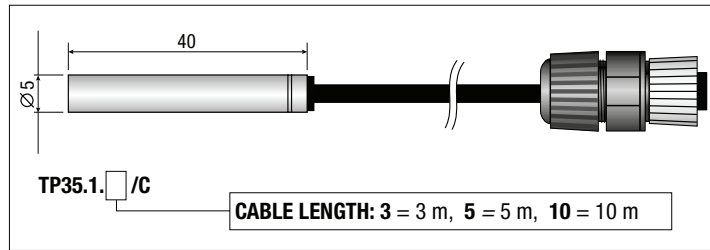

TP35.2... Temperature probe with **Pt1000** 1/3 DIN 3-wire sensor. Operating temperature: 0...+70 °C. Dimensions: Ø 5 x 20 mm. Thermoplastic rubber tube. M12 4-pole female connector.

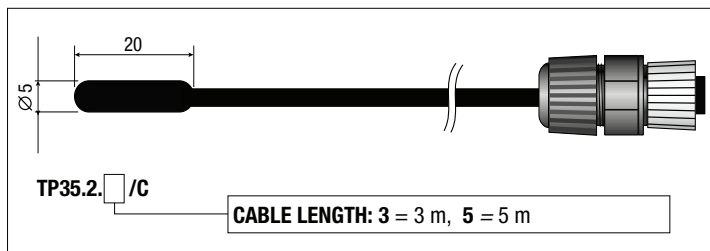

TP35.5... Temperature probe with **Pt1000** 1/3 DIN 3-wire sensor. Operating temperature: -40...+300 °C. Dimensions: Ø 4 x 100 mm. AISI 316 stainless steel tube. M12 4-pole female connector.

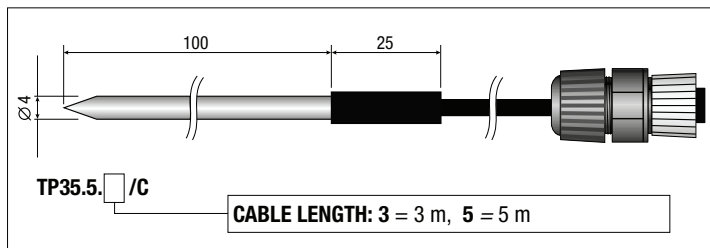

Note: the TP35... temperature only probes with Pt1000 sensor can not be connected to the models HD208[L]17PTC...

Temperature and relative humidity combined probes

HP3517... Temperature and relative humidity combined probe. R.H. sensor measuring range: 0...100%. Temperature sensor: NTC10kΩ @ 25 °C (HP3517TC...) or Pt1000 (HP3517E2TC...). NTC10kΩ sensor measuring range: -40...+105 °C. Pt1000 sensor measuring range: -40...+150 °C. R.H. sensor operating temperature: -40...+80 °C standard, -40...+150 °C with **E2 option**. M12 4-pole (HP3517TC...) or 8-pole (HP3517E2TC...) female connector. Pocan® plastic body.

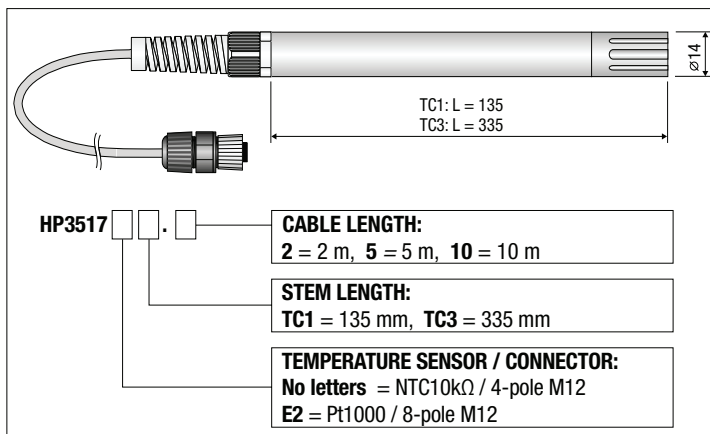

Accessories

HD35AP-S Additional copy of the CD-ROM with basic HD35AP-S software for the configuration of the instrument, the monitoring and downloading of data in the database. For Windows® operating systems.

HD35AP-PLUS Advanced version of the HD35AP-S software allowing **multi-client connection to the Database**.

HD35AP-CFR21 Advanced version of the HD35AP-S software including, **in addition to the features of the PLUS option**, the management of the data logging system in accordance with the **FDA 21 CFR part 11 recommendations**.

CP23 Direct USB connection cable with mini-USB male connector on the instrument side and USB type A male connector on the PC side.

HD208.13 Aluminium flange for fixing the instrument to the wall.

HD35-BAT2 3.6 V **non-rechargeable** lithium-thionyl chloride (Li-SOCl₂) battery, size AA, 2-pin Molex 5264 connector.

HD75 Saturated solution for testing the Relative Humidity probes at 75% RH, supplied with adapter for probes diameter 14 mm thread M12x1.

HD33 Saturated solution for testing the Relative Humidity probes at 33% RH, supplied with adapter for probes diameter 14 mm thread M12x1.

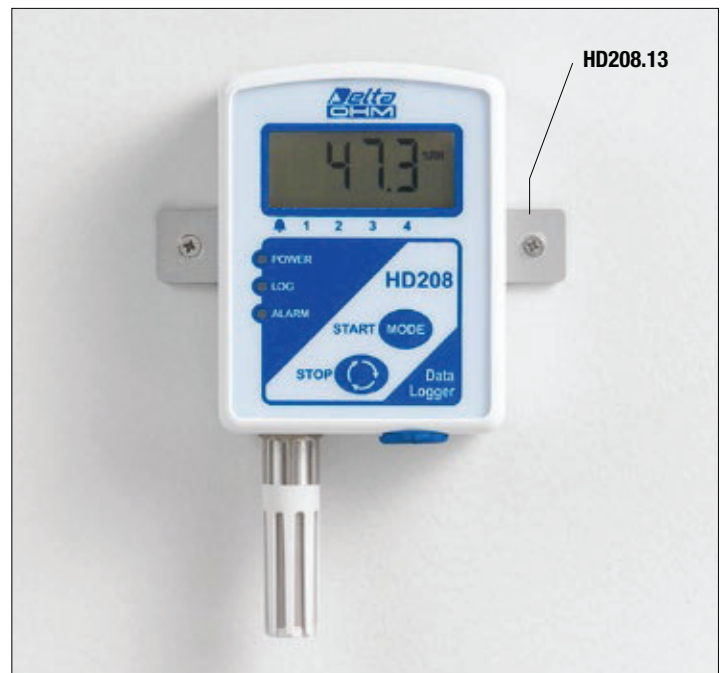

MANUFACTURE OF PORTABLE, BENCH TOP AND PROCESS SCIENTIFIC INSTRUMENTS

Current and voltage loop transmitters and regulators

Temperature - Humidity, Dew point - Pressure - CO, CO₂

Air speed - Light - Optical Radiation

Acoustics - Vibration

Data logger - Data logger wireless

Microclimate

pH - Conductivity - Dissolved Oxygen - Turbidity

Elements for weather stations



LAT N° 124 Signatory of EA, IAF and ILAC Mutual Recognition Agreements

Temperature - Humidity - Pressure - Air speed

Photometry/Radiometry - Acoustics

CE CONFORMITY

Directives:

- Low Voltage Directive 2014/35/EU
- Electromagnetic Compatibility Directive 2014/30/EU
- RoHS Directive 2011/65/EU

Harmonised standards:

- Safety EN 61010-1:2010
- EMC EN 61326-1:2013
- RoHS EN 50581:2012



Delta Ohm srl

Via G. Marconi, 5

35030 Caselle di Selvazzano (PD) - Italy

Tel. 0039 0498977150 r.a.

Fax 0039 049635596

e-mail: info@deltaohm.com

Web Site: www.deltaohm.com

